

WOODWARM STOVES
 WildWood 9kw *Woodburner Only*
 Low Curve Canopy

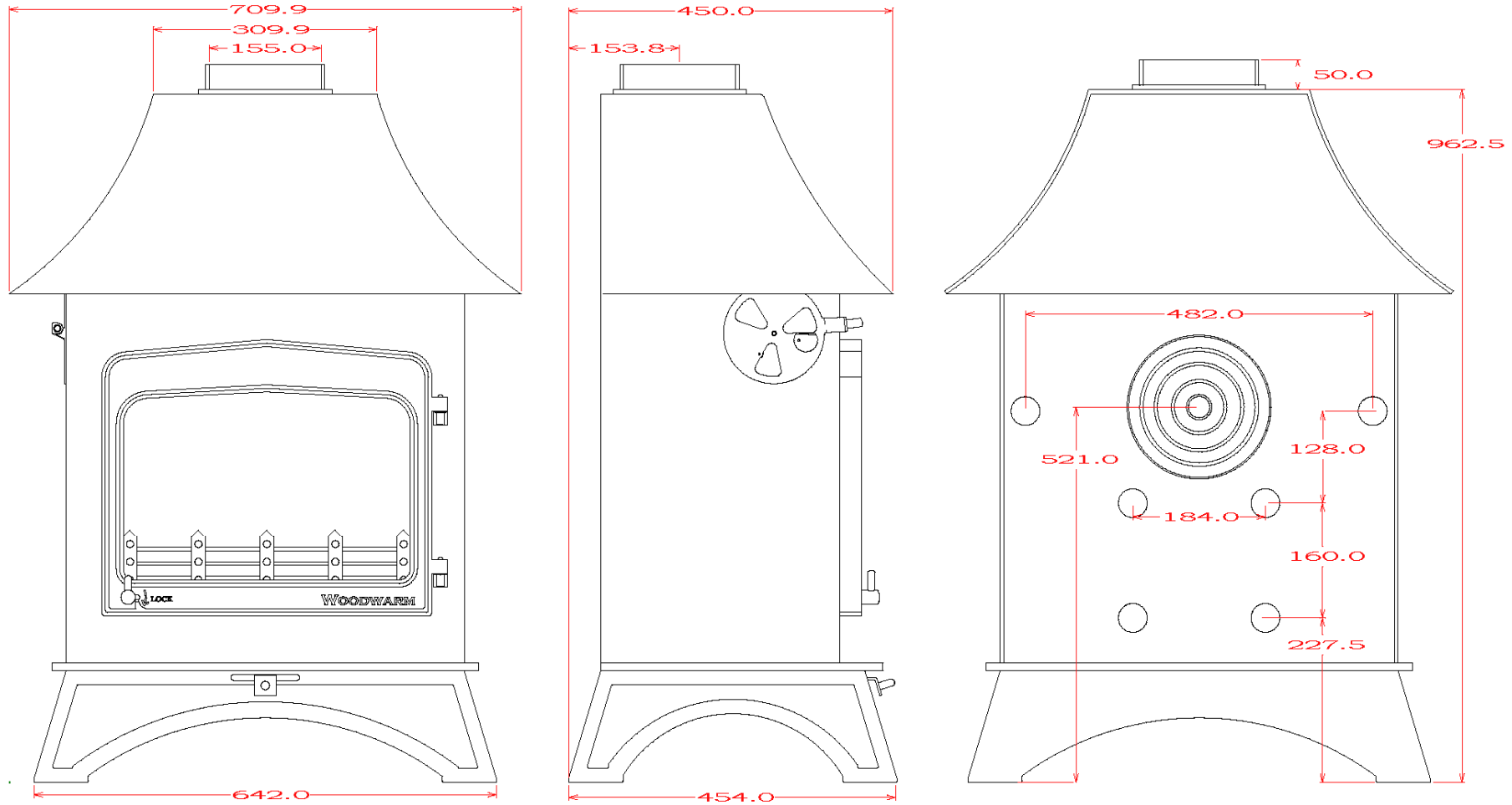

Maximum Log Length:-430mm

Efficiency:-78.5% Wood 74.7% Ancit

Boilers in Range:- 8,000 btu's (7.0kw Heat left to room) 20,000 btu's (5.9kw Heat left to room) 30,000 btu's (4.5kw Heat left to room)

Max Boiler Available with Roof Boiler:- 38,000 btu's (2.2kw Heat left to room)